

LC-RA1215P/P1*1

FOR MAIN AND STANDBY POWER SUPPLIES.
 EXPECTED TRICKLE DESIGN LIFE: 6 - 9 YEARS AT 20°C
 ACCORDING TO EUROBAT.

DIMENSIONS (MM)

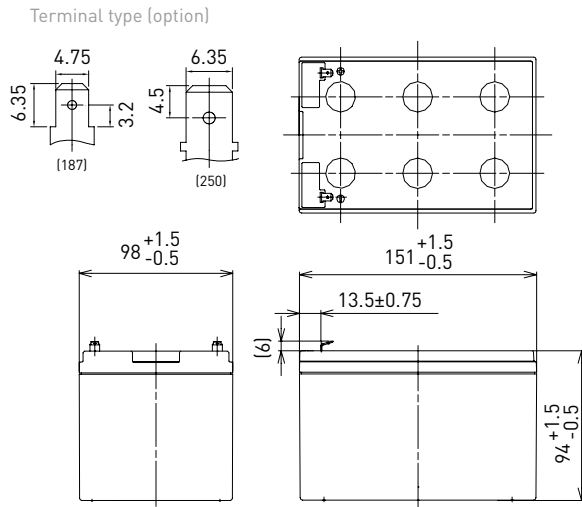

Contents indicated (including the recycle marking, etc.) are subject to change without notice. Battery case resin: standard (UL94 HB)

Specifications		LC-RA1215P/P1*1
Nominal voltage (V)		12
Nominal capacity	20 hours rate (Ah)	15.0
Dimensions	Length (mm)	98
	Width (mm)	151
	Total height (mm)	100
Approx. mass (kg)		4.15
Terminal type		Faston 187/250
Capacity (25°C)	20 hours rate (Ah)	15.0
	10 hours rate (Ah)	13.0
	3 hours rate (Ah)	12.0
	1 hour rate (Ah)	10.0
Impedance (mΩ)	Fully charged battery (25°C)	15
	Temperature dependency of capacity (%) - 20 hours rate	
	40°C	102
	25°C	100
	0°C	85
	-15°C	65
Remaining capacity (25°C)	After 3 months (%)	91
	After 6 months (%)	82
	After 12 months (%)	64

DURATION OF DISCHARGE VS. DISCHARGE CURRENT

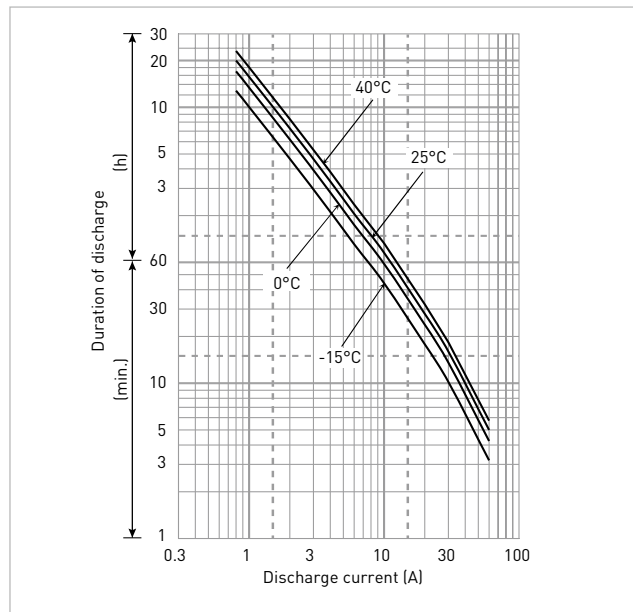

WATT TABLE (25°C)

(Wattage/battery)

Cut-off	3min.	5min.	10min.	15min.	20min.	30min.	45min.	1h	1.5h	2h	3h	4h	5h	6h	10h	20h
9.6V	850	682	455	350	292	217	157	123	83.9	65.0	47.1	36.0	29.9	25.2	16.2	8.75
9.9V	799	646	444	343	286	213	156	122	82.8	64.6	46.9	35.8	29.7	25.1	16.1	8.74
10.2V	741	607	433	336	281	211	154	121	81.4	63.4	46.4	35.7	29.5	24.9	15.9	8.72
10.5V	667	555	404	318	270	206	152	118	80.1	61.9	45.7	35.5	29.4	24.8	15.8	8.70
10.8V	576	497	368	300	263	199	146	116	77.7	59.6	44.8	35.1	28.9	24.5	15.7	8.66

AMPERE TABLE (25°C)

(Ampere/battery)

Cut-off	3min.	5min.	10min.	15min.	20min.	30min.	45min.	1h	1.5h	2h	3h	4h	5h	6h	10h	20h
9.6V	76.5	61.2	40.6	30.4	25.2	18.5	13.4	10.50	7.11	5.49	3.96	3.01	2.49	2.10	1.35	0.755
9.9V	71.8	58.0	39.7	29.9	24.7	18.2	13.3	10.40	7.01	5.45	3.94	3.00	2.48	2.09	1.34	0.753
10.2V	66.6	54.5	38.6	29.2	24.2	18.1	13.1	10.30	6.89	5.36	3.90	2.99	2.46	2.08	1.33	0.752
10.5V	59.9	49.8	36.1	27.6	23.3	17.6	13.0	10.00	6.78	5.22	3.84	2.97	2.45	2.07	1.32	0.750
10.8V	51.8	44.6	32.9	26.1	22.7	17.0	12.5	9.82	6.58	5.03	3.77	2.94	2.41	2.04	1.31	0.747

All mentioned values are average values

*1 This battery is also available with a flame-retardant battery case resin (UL94 V-0): LC-VA1215P/P1.

LC-RA1215P/P1*1

CHARGING METHOD (25°C)

Cycle use	Control voltage: 14.5V - 14.9V Initial current: 6A or smaller
------------------	--

CUT-OFF VOLTAGE

Discharge current	0.75A - 3A	3A - 7.5A	7.5A - 15A	15A - 30A	30A - 45A
Cut-off voltage	10.5V	10.2V	9.9V	9.3V	8.7V

CYCLE LIFE VS. DEPTH OF DISCHARGE (ACC. IEC 61056)

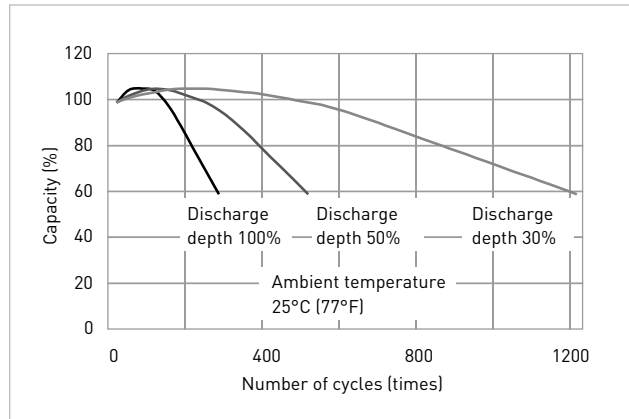

RESIDUAL CAPACITY TEST RESULT

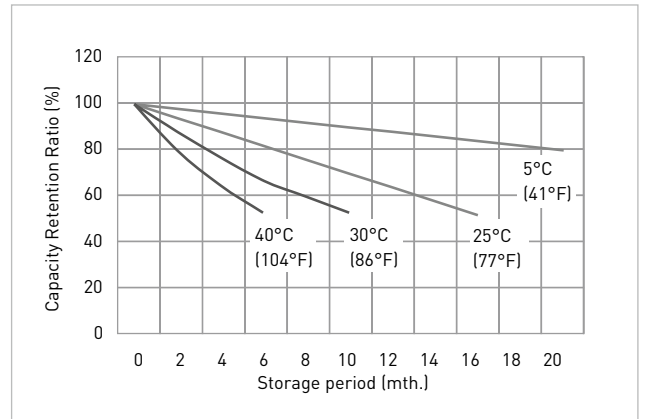

CONSTANT-VOLTAGE CONSTANT-CURRENT CHARGE CHARACTERISTICS FOR CYCLE USE

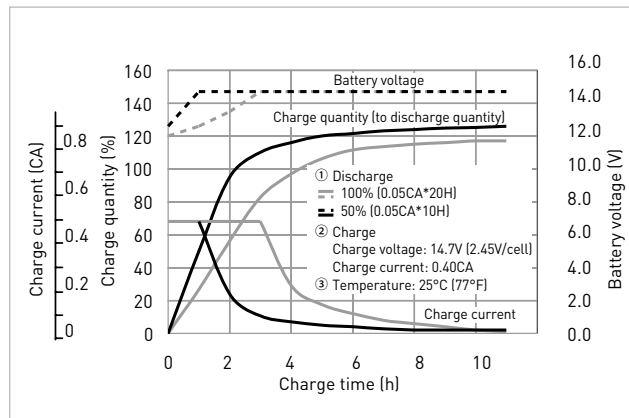

DISCHARGE CAPACITY BY TEMPERATURE AND BY DISCHARGE CURRENT

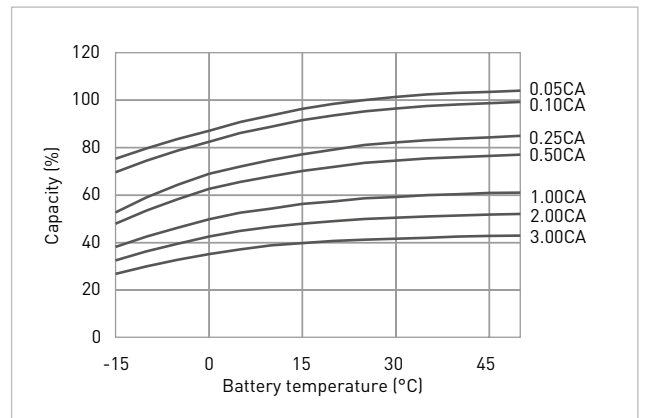

DISCHARGE CHARACTERISTICS

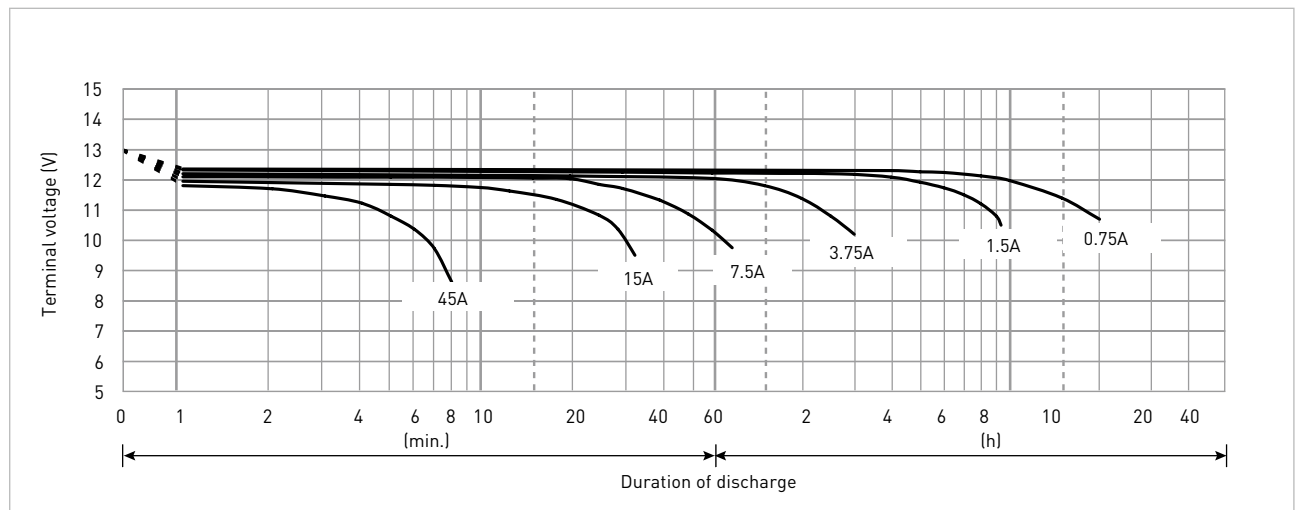

*1 This battery is also available with a flame-retardant battery case resin (UL94 V-0): LC-VA1215P/P1.