

# CYCLON<sup>®</sup>

---

## SELECTION GUIDE

---

FOURTH EDITION



**EnerSys**<sup>™</sup>  
Power/Full Solutions



# CYCLON®

## Preface to the Fourth Edition

EnerSys™ is the world's largest industrial battery manufacturer. Headquartered in Reading, PA, USA, EnerSys has 22 manufacturing and assembly plants, over 7,000 employees, and a worldwide sales and distribution network. A leader in both valve-regulated and flooded lead acid battery technologies, EnerSys is a major supplier to telecommunications, UPS, data processing, electronic, and material handling markets across the globe.

EnerSys operates several of the first lead acid battery plants in the United States to receive the ISO 9001 certificates of registration, covering the company's product design, manufacturing, assembly, and customer service functions. ISO 9001 certification, covering 20 key elements, assures customers that EnerSys has fully documented and implemented manufacturing and quality systems that are consistently followed.

EnerSys' environmentally progressive Warrensburg, Missouri plant, home base of the CYCLON® product lines, covers 30,000 square meters on 13 hectares and employs more than 400 people. EnerSys was the first battery company in the United States to receive ISO 14001 certification. ISO 14001 focuses on the environmental management system of the business and provides a systematic approach to resource conservation.

EnerSys supports its customers through global field sales offices and a select network of authorised Value Added Centres and international representatives and distributors. EnerSys offers technical support and customer service unparalleled in the industry. Additionally, the sales and support team is committed to meeting and exceeding the individual needs of each customer.



*EnerSys' Warrensburg plant covers 30,000 square meters and is situated on 13 hectares*



## TABLE OF CONTENTS

### Company background

EnerSys	2
Services and applications	4
Features and benefits	5

### Technical information

Capacity as a function of temperature	7
State of charge	7
Storage time as a function of temperature	7
Charging recommendations	7

### CYCLON Single Cells

CYCLON product family	8
CYCLON alternate battery configurations	9
CYCLON standard battery descriptions	9
CYCLON Single Cell performance specifications	10
CYCLON Single Cell standard assemblies	11
CYCLON BC Single Cell performance specifications	12
CYCLON Single Cell mechanical specifications	13
CYCLON BC Single Cell mechanical specifications	13
CYCLON Single Cell constant current (CC) and constant power (CP) discharge graphs	14

### CYCLON Monobloc

4V/6V Monobloc performance specifications	15
4V/6V Monobloc standard assemblies	16
4V/6V Monobloc mechanical specifications	17
4V/6V Monobloc constant current (CC) and constant power (CP) discharge graphs	18

### Quick reference list

Standard product listing	19
--------------------------	----



## Value-Added Services

In addition to our manufacturing capability, EnerSys is proud to provide its customers with the following services:

- customised manufacturing design
- battery recycling
- on-line Internet technical information
- charging support
- product testing
- on-site technical seminars
- battery samples
- application engineering
- technical documentation
- charger evaluation to determine compatibility with CYCLON products



## Applications

Batteries from EnerSys' "pure lead-tin" family are used in a wide variety of standby and portable/cyclic applications including those in:

- telecommunications
- electronics
- uninterruptible power supplies
- defence installations
- aviation (may require FAA or other appropriate agency certification/approval for installation in aircraft)
- computer back-up
- electric vehicles
- medical equipment
- solar power
- lawn and garden equipment
- extreme temperature environments (-65°C to +80°C) for single cells



## Features and Benefits

Sealed pure-lead cells were invented by the Gates Corporation in 1973. The purity of the materials used is key to supporting the CYCLON battery's performance benefits. A longer service life, meaning fewer replacements and the cost associated with it, combined with higher reliability and fewer system failures, result in a lower long-term cost of ownership to the end user or equipment owner.

What are the advantages of EnerSys technology?

**1. Power density** - Per unit weight, the power provided by pure lead-tin products offers the greatest high-rate power density for your energy dollar. CYCLON's greater volumetric power allows engineers to consider more energy-supporting features or design smaller, lighter packages.

At high-rate and pulse discharges, EnerSys' CYCLON products offer the best performance value when compared with competitive product in applications at less than 100 minutes of discharge.

**2. Cycle life** - Compared to competitive lead products (offering up to 200 full cycles), pure lead-tin batteries provide 50% to 200% greater full cycle capability. CYCLON product will deliver up to 300 cycles (100% DOD, C/5). And, because CYCLON incorporates a high vent-pressure design, EnerSys' products experience no "dry out" failure mode from repeated recharges.

**3. Float life** - Conventional sealed-lead batteries vary greatly in specified standby life: from three to six years at 20°C, C/20. CYCLON Single Cells, however, offer a ten-year design life at 25°C, C/5, to 80% of rated capacity. At 20°C, CYCLON Single Cells offer a fifteen-year design life.

**4. High stable voltage delivery** - The high stable voltage delivery of a pure lead-tin battery results from its low internal resistance. The flat discharge voltage profile of our batteries, similar to nickel cadmium, combined with our products' low internal resistance, means our batteries are able to discharge and recharge their power more quickly and efficiently and offer greater application flexibility. The pure lead-tin construction also gives more watts-per-unit weight at high discharge rates.

**5. Safety** - Since CYCLON Single Cells and Monoblocs emit minimal to no gassing under normal charging conditions they are safe for installation in offices, aircraft cabins, hospitals or any other environment occupied by human beings. Underwriters Laboratories (UL) recognises all CYCLON cells and batteries as components.

**6. Widest temperature range** - Due to the product's strong construction and high vent pressures, these cells will maintain their performance and physical parameters in extreme conditions. At high temperatures, the chemical reaction in a battery that causes ageing is accelerated. Pure lead-tin technology resists that chemical reaction more effectively than alloyed lead, thus allowing a battery to have a longer service life. At high temperatures, when conventional lead batteries experience internal moisture loss from venting and case side wall distention, the CYCLON Single Cell, with its steel can (jacket) and 344 kPa vent, does not experience these life-robbing conditions. CYCLON has twice the delivered capacity of conventional sealed-lead batteries at temperatures below -20°C, offering unparalleled low-temperature performance.

Our batteries have thinner plates, and therefore greater plate surface area than conventional sealed-lead, thick plate batteries. As a result our batteries can reach a high state of charge in fast-charging applications in one-fourth the time of conventional, sealed-lead, thick-plate batteries. This is 50% to 100% overall better performance for your energy money.

**7. Rugged construction** - Due to their strong external packaging and internal pure lead-tin composition, EnerSys' products can withstand not only extreme temperatures but also harsh usage.

CYCLON Single Cells are available housed in cases constructed of UL 94V-0 rated material. The CYCLON Single Cell itself is in a metal jacket giving added flammability protection. CYCLON products are shock and vibration resistant, designed to offer higher tolerance levels to meet demanding applications, including those in commercial and outdoor applications. The company's focus on battery-case integrity and high vent pressure, coupled with pure lead-tin's low grid-corrosion rate, means CYCLON cells and Monoblocs provide the longest service life possible.

### CYCLON Single Cell/Monobloc comparison chart

	Design	Construction	Operating range	Voltages
Single Cells	304 kPa venting pressure	Metal outer case & spiral construction	-65°C to +80°C	2 volt cells
Monobloc	50 kPa venting pressure	Plastic outer case & spiral construction	-40°C to +40°C	4 & 6 volt units

## The pure lead-tin advantage

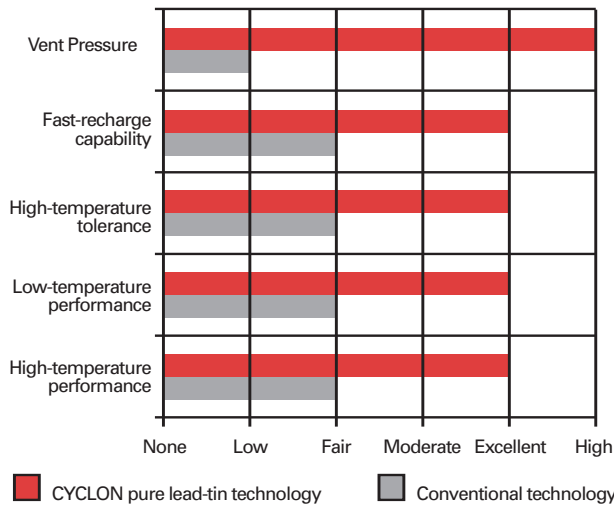

Each plastic Monobloc consists of Single Cell elements, internally connected to provide a 4 or 6 volt unit. Monoblocs or Single Cells can be connected in series or parallel to achieve the required voltage or capacity. Monoblocs and Single Cells are supplied with spade terminals making electrical connections quick and easy. Additionally, EnerSys products offer the highest vent pressure in the market. As a result, our batteries are more resistant to venting and dryout from continuous overcharge in standby applications.

- 8. Fastest recharge** - EnerSys' pure lead-tin chemistry allows our batteries and cells to offer the highest recharge efficiency of any sealed-lead battery on the market. With pure lead-tin, you can achieve a 95% state of recharge in less than one hour - without loss of capacity or electrolyte using conventional constant-voltage charging techniques.

Flexible charging options are possible with CYCLON Single Cells and Monoblocs, as no current limit is required when using a constant voltage charger.

- 9. Orientation/placement/transport** - Due to the products' mechanical design, CYCLON can be mounted and operated in any position, an attractive feature for less accessible areas.

CYCLON Single Cells offer UL 94V-0 flame-retardant packaging, thus allowing the mounting of systems in sensitive areas and human environments. Plus, the unique and flexible 2-volt CYCLON Single Cell allows you to design your system using an almost infinite number of packaging/design configurations.

Effective September 30, 1995, CYCLON Single Cells and Monoblocs were classified as "nonspillable

batteries", and are excepted from the USA's Department of Transportation's (DOT) comprehensive packaging requirements if the following conditions are satisfied: (1) The battery is protected against short circuits and is securely packaged and (2) The battery and outer packaging must be plainly and durably marked "NONSPILLABLE" or "NONSPILLABLE BATTERY". CYCLON shipments from EnerSys Warrensburg location, will be properly labelled in accordance with applicable regulations. Packaging changes performed at other locations may require additional labelling, since in addition to the battery itself containing the required marking, the outer packaging of the battery must also contain the required marking: "NONSPILLABLE" or "NONSPILLABLE BATTERY".

CYCLON Single Cells and Monoblocs have been tested and determined to be in compliance with the vibration and pressure differential tests contained in 49 CFR § 173.159(d).

Because CYCLON Single Cells and Monoblocs are classified as "Nonspillable" and meet the conditions above, [from § 173.159(d)] they do not have an assigned UN number nor do they require additional DOT hazard labelling.

The regulation change effective September, 1995, was to clarify and distinguish to shippers and transporters, all batteries that have been tested and determined to be in compliance with the DOT Hazardous Material Regulations, the International Civil Aeronautics Organisation (ICAO), and the International Air Transport Association (IATA) Packaging Instruction 806 and Special Provision A67, and therefore excepted from all other requirements of these regulations and classified as a "nonspillable battery".

- 10. Shelf life** - Pure lead-tin batteries have an extremely low self-discharge rate, thus providing extended storage capability while maintaining high state-of-charge levels for dependable operation.

CYCLON Single Cells and Monoblocs have a shelf life more than two times that of conventional lead batteries. To assure maximum reliability, EnerSys recommends that all stored cells/batteries be recharged (boost charged) once every 24 months or when the open circuit voltage drops to 2.00 volts per cell, whichever occurs earlier. Inventory should be checked more frequently if storage temperature regularly exceeds 25°C.

**Capacity as a function of temperature for CYCLON Single Cells & Monoblocs (use graph up to 40°C for Monoblocs)**

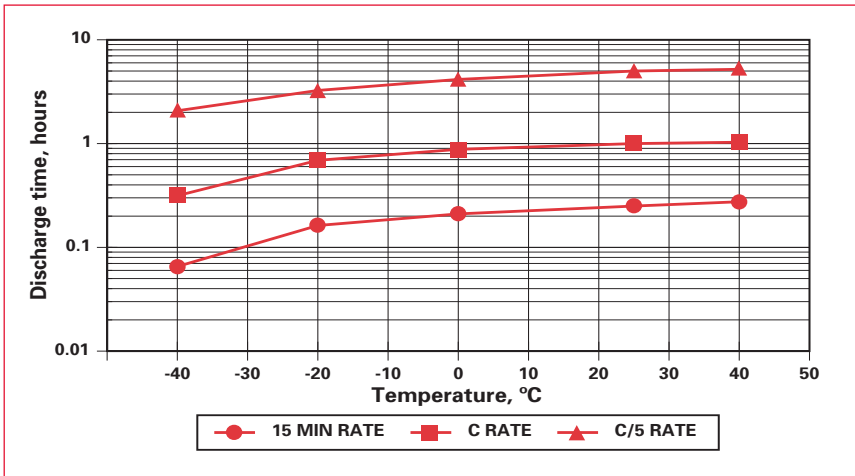

**State of charge for CYCLON Single Cells & Monoblocs**

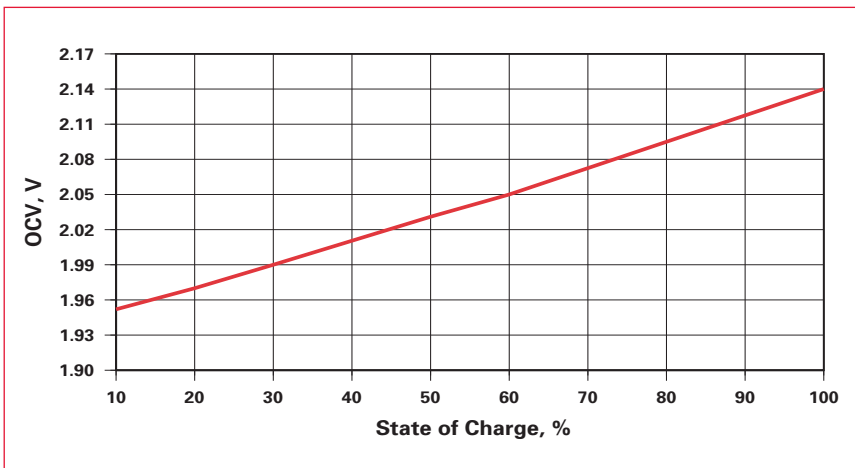

**Storage time as a function of temperature for CYCLON Single Cells & Monoblocs (fully charged cell)**

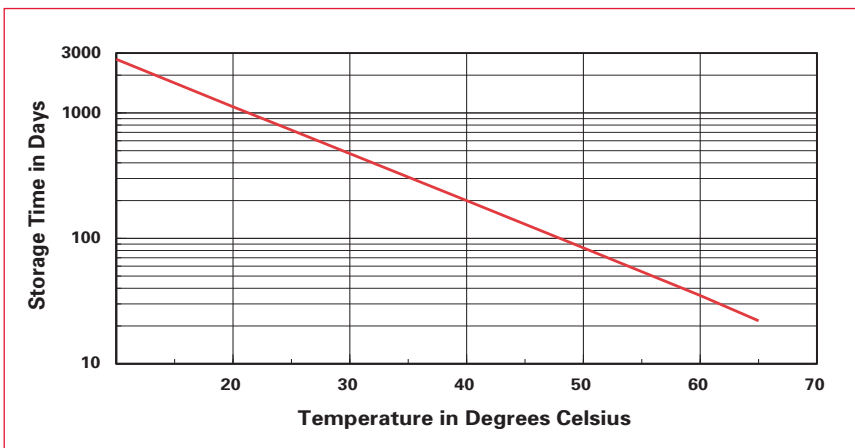

**Charging recommendations:**

Broadly speaking, a battery may be recharged using either a constant voltage (CV) charger or a constant current (CC) charger, or a modification of either or both of these.

The exact regime chosen generally depends upon the time and economic constraints imposed by the system. Constant current charging is widely used in cyclic applications where a recharge must be accomplished in a relatively short time period. Constant voltage charging, where a single voltage level is applied across the battery terminals, is the most suitable method to recharge CYCLON products. Depending on the CV charger’s current limit, it is possible to recharge these batteries from a 100% discharged condition to better than 95% state of charge in less than one hour, using only the cyclic charge voltage.

**Constant voltage charging**

Constant voltage (CV) charging should be within the following ranges:

- Fast Chargers, Per cell:  
2.45 to 2.50 volts @ 25°C
- 12 volts:  
14.70 to 15.0 volts @ 25°C  
(for a maximum of 16-20 hours)
- Float Chargers, Per cell:  
2.27 to 2.35 volts @ 25°C
- 12 volts:  
13.62 to 14.10 volts @ 25°C

To avoid thermal runaway in warmer temperatures, and to improve charge acceptance in colder temperatures, the charger voltage should be compensated by approximately 3 millivolts per cell per degree Centigrade variance from 25°C. This is a negative coefficient, with the voltage being lowered as the temperature increases, and vice versa.

There is no need to limit the inrush current to the battery during constant voltage charging. The low internal resistance of EnerSys CYCLON Single Cells and Monoblocs allows for large inrush current without damage.

Since not all of the charge returned is accepted to replenish the electro-chemical potential, a good rule of thumb to use is that the charge returned should be 105% to 110% of the capacity delivered on the previous discharge.

Most current waveforms are not pure DC nor are they pure sine waves. Therefore, consult the EnerSys Application Support Department for assistance when evaluating the charger current waveforms for your specific application.

A three-step 6-8 hour charge profile optimised for CYCLON cells and batteries is available on request from the Technical Support Department of EnerSys.

## CYCLON product family (All capacities are C<sub>10</sub> to 1.67Vpc @ 25°C)

### CYCLON 2V Single Cell:

Products	Capacity	Part Number	Internal res. of fully charged cell mΩ @ 25°C	Nominal short circuit current for charged cell	DIMENSIONS				
					Diameter mm	Height mm	Height with terminals mm	Weight gm	Tabs mm
D cell	2.5Ah	0810-0004	5.0	400A	34.3	61.2	68.1	178.0	4.75x0.64
DT cell	4.5Ah	0860-0004	5.0	400A	34.3	96.0	102.9	274.4	4.75x0.64
X cell	5.0Ah	0800-0004	3.5	570A	44.5	72.9	81.5	362.0	6.35x0.64
E cell	8.0Ah	0850-0004	3.0	665A	44.5	100.1	108.7	489.9	6.35x0.64
J cell	12.0Ah	0840-0004	2.5	800A	51.8	123.2	135.6	839.2	7.92x0.81
BC cell	25Ah	0820-0004	1.5	1335A	65.3	158.8	173.2	1669.2	M6 (-) and M8 (+) terminals

### CYCLON 4V Monoblocs:

Products	Capacity	Part Number	Internal res. of fully charged Monobloc mΩ @ 25°C	Nominal short circuit current for charged cell	DIMENSIONS				
					Length mm	Width mm	Height mm	Weight kg	Tabs mm
D cell	2.5Ah	0819-0010	10.0	400A	79.5	46.0	69.9	.36	4.75x0.64
X cell	5.0Ah	0809-0010	7.0	570A	96.5	53.8	76.7	.74	6.35x0.64
E cell	8.0Ah	0859-0010	6.0	665A	96.8	54.1	101.6	.96	6.35x0.64

### CYCLON 6V Monoblocs:

Products	Capacity	Part Number	Internal res. of fully charged Monobloc mΩ @ 25°C	Nominal short circuit current for charged cell	DIMENSIONS				
					Length mm	Width mm	Height mm	Weight kg	Tabs mm
D cell	2.5Ah	0819-0012	15.0	400A	113.8	46.0	69.9	.52	4.75x0.64
X cell	5.0Ah	0809-0012	10.0	570A	139.2	53.8	76.7	.98	6.35x0.64
E cell	8.0Ah	0859-0012	8.0	665A	139.2	54.1	101.6	1.43	6.35x0.64



## CYCLON Single Cell

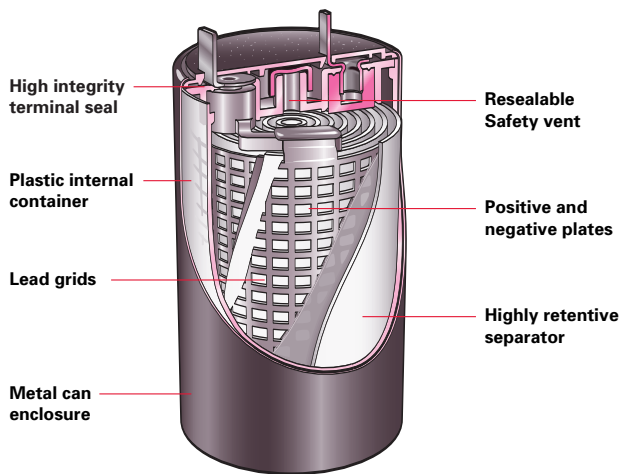

## Alternative battery configurations

Standard battery configurations are rectangular in overall shape. A sample of other possible configurations are illustrated below. These can be held together with tape (offering the lowest cost and minimum electrical and mechanical protection) or by shrink wrapping. The CYCLON Single Cell can be custom configured in virtually an infinite number of designs.

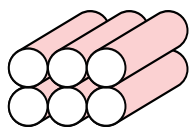

Rectangular

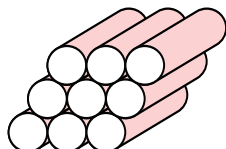

Rhomboid

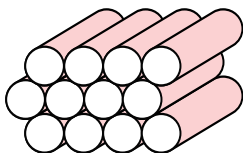

Nested

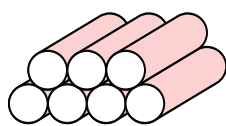

Trapezoid

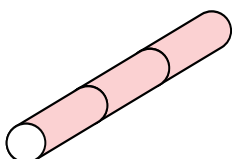

Tubular

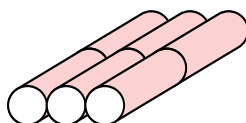

Flat Pack

## CYCLON standard battery descriptions

CYCLON cells are ideal for small ampere-hour applications up to 25Ah. The sealed-lead construction uses a starved-electrolyte system and a patented grid-alloy providing numerous advantages.

Standard batteries are offered based on combinations of the previously described CYCLON cells and are available in 6 and 12 volt configurations with capacities ranging from 2.5Ah to 25Ah.

### Battery Packages

Rigid plastic cases or shrink wrap packaging are available.

### Rigid Plastic

Cases are available for most designs in either flame-retardant ABS material, meeting UL 94V-0 flammability rating, or Styrene (available only in 2X3 D and X battery configurations). Some cases have mounting holes. Rigid plastic cases are recommended for applications in which the battery must withstand vibration, movement or extreme weather conditions.

### Shrink Wrap

Shrink wrap packaging is less expensive and smaller in size and weight. A plastic extrusion insulates the battery top and keeps the cells in line. A heavy duty shrink sleeve holds the cells firmly in place. Shrink wrap packaging is recommended for applications in which the battery remains stationary.

## Battery Terminations for Single Cell and Monoblocs

### Tab/Stud

Cell size	Dimensions mm
D	4.75 x 0.64
DT	4.75 x 0.64
X	6.35 x 0.64
E	6.35 x 0.64
J	7.92 x 0.81
BC	6mm post (negative) 8mm post (positive)

### Tab Adapters (D, DT, X, and E)

Available to convert 4.75mm tabs to 6.35mm tabs, 0.81mm thick, and vice versa.

### BC Quick Disconnect Terminals

AMP series 250 Faston terminals are available for BC batteries.

### Connection Terminations

A wide variety of terminations are offered.

For recommendations or to specify; contact your EnerSys Territory Manager or battery assembler.

**Fusible Links**

Specify your requirement.

**Lead Wires**

Stranded copper wire with insulation meeting UL1015 specifications (Red +, Black -). Standard leads extend approx 230mm outside the battery pack. Ends are stripped and dipped in wax, which must be removed before use.

Standard wire gauges are:

D batteries	18AWG, UL1015 (approx 1.02mm)
DT batteries	16AWG, UL1015 (approx 1.29mm)
X batteries	16AWG, UL1015 (approx 1.29mm)
E batteries	14AWG, UL1015 (approx 1.63mm)
J batteries	14AWG, UL1015 (approx 1.63mm)
BC batteries	12AWG, UL1015 (approx 2.05mm)

Varying lead lengths and gauges are also available; please specify to your EnerSys Territory Manager or battery assembler.

**Intercell Connections**

*Standard*

- D, DT, X and E batteries—welded tin-plated steel connector
- J batteries—soldered, stranded wire
- BC batteries—solid copper

*For vibration-prone applications*

- D, DT, X, E and J batteries—soldered, stranded wire
- BC batteries—braided copper straps

**CYCLON Single Cell performance specifications**

**Constant current discharge - amps to 1.67Vpc @ 25°C**

Products	DURATION									
	5 min	10 min	15 min	30 min	60 min	90 min	5 hr	8 hr	10 hr	20 hr
D cell (2.5Ah)	14.8	8.1	5.9	3.4	1.9	1.4	.48	.32	.26	.13
DT cell (4.5Ah)	25.2	15.0	11.2	6.6	3.7	2.6	.85	.55	.45	.24
X cell (5.0Ah)	27.3	17.8	13.2	7.0	3.9	2.8	.96	.61	.50	.26
E cell (8.0Ah)	41.7	26.4	19.0	11.0	6.2	4.4	1.6	1.0	.81	.42
J cell (12.0Ah)	51.7	38.1	29.4	18.0	9.2	6.5	2.3	1.5	1.20	.66

**Constant power discharge - watts per cell to 1.67Vpc @ 25°C**

Products	DURATION									
	5 min	10 min	15 min	30 min	60 min	90 min	5 hr	8 hr	10 hr	20 hr
D cell (2.5Ah)	26.4	16.1	11.6	6.7	3.8	2.7	.94	.61	.50	.25
DT cell (4.5Ah)	45.0	28.1	21.0	12.5	7.1	5.1	1.7	1.1	.90	.46
X cell (5.0Ah)	45.4	31.9	23.9	13.9	7.8	5.6	1.9	1.2	1.0	.51
E cell (8.0Ah)	77.8	51.0	35.5	21.1	12.4	8.9	3.1	2.0	1.6	.85
J cell (12.0Ah)	90.4	68.4	53.4	31.6	18.3	13.2	4.7	3.0	2.3	1.3

**Charging Voltage/Temperature/Life:**

Products	CHARGING VOLTAGE PER CELL		TEMPERATURE RANGE		LIFE EXPECTANCY	
	Cyclic	Float	Storage & discharge	Charge	C/5 Cycle life 100% DOD	Float life at 25°C (20°C)
D, DT, X, E & J cell	CV 2.45-2.50 CC*	CV 2.27-2.35 CC*	-65°C to +80°C	-40°C to +80°C	300	10 years (15 years)

*Maximum recommended storage time before recharge - 24 months @ 25°C or 2.0Vpc, whichever is earlier*

*Atmospheric pressure range - Vacuum to 810 kPa*

*\*Users planning to use CC should consult the EnerSys Application Support Department*

**UL Recognised Component. Meets UL 1989**

Caution: Batteries contain toxic materials (Pb and H2SO4) • Avoid short circuit • Do not charge in gas-tight container  
Sealed-lead rechargeable battery must be recycled or disposed of properly. Contact EnerSys Customer Service for details.



## CYCLON Single Cell standard assemblies

### CYCLON 6 Volt 1x3 Shrink Wrap

Product Number	Description	Length mm	Width mm	Height mm	Weight kg	Leads
0810-0102	2.5Ah D Dbl. Slot	102.9	37.6	67.6	.56	No
0810-0103	2.5Ah D	102.9	37.6	67.6	.57	Yes
0860-0102	4.5Ah DT Dbl. Slot	102.9	37.6	102.4	.94	No
0860-0103	4.5Ah DT	102.9	37.6	102.4	.95	Yes
0800-0102	5.0Ah X Dbl. Slot	133.4	47.5	79.2	1.13	No
0800-0103	5.0Ah X	133.4	47.5	79.2	1.14	Yes
0850-0102	8.0Ah E Dbl. Slot	133.4	47.5	106.4	1.58	No
0850-0103	8.0Ah E	133.4	47.5	106.4	1.60	Yes



### CYCLON 6 Volt 1x3 ABS Case

Product Number	Description	Length mm	Width mm	Height mm	Weight kg	Leads
0810-0011	2.5Ah D Dbl. Slot	107.4	39.4	69.9	.60	No
0810-0077	2.5Ah D Sing. Slot	107.4	39.4	69.9	.62	Yes
0800-0011	5.0Ah X Dbl. Slot	138.2	49.8	80.3	1.23	No
0800-0071	5.0Ah X Sing. Slot	138.2	49.8	80.3	1.24	Yes



### CYCLON 12 Volt 2x3 Shrink Wrap

Product Number	Description	Length mm	Width mm	Height mm	Weight kg	Leads
0810-0114	2.5Ah D Dbl. Slot	102.9	71.6	67.8	1.13	No
0810-0115	2.5Ah D	102.9	71.6	67.8	1.14	Yes
0860-0114	4.5Ah DT Dbl. Slot	102.9	71.6	102.4	1.76	No
0860-0115	4.5Ah DT	102.9	71.6	102.4	1.77	Yes
0800-0114	5.0Ah X Dbl. Slot	133.4	93.5	79.5	2.24	No
0800-0115	5.0Ah X	133.4	93.5	79.5	2.26	Yes
0850-0114	8.0Ah E Dbl. Slot	133.4	93.5	106.4	3.05	No
0850-0115	8.0Ah E	133.4	93.5	106.4	3.07	Yes

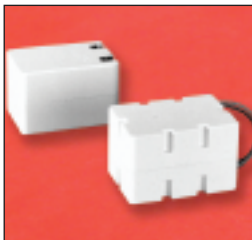

### CYCLON 12 Volt 2x3 ABS and Styrene Cases

Product Number	Description	Length mm	Width mm	Height mm	Weight kg	Leads
0810-0008	2.5Ah D Dbl. Slot	107.4	73.2	69.1	1.22	No
0810-0067*	2.5Ah D (Styrene)	107.4	75.4	69.3	1.19	Yes
0800-0008	5.0Ah X Dbl. Slot	138.2	94.0	79.8	2.42	No
0800-0047*	5.0Ah X (Styrene)	138.2	94.0	81.0	2.37	Yes



### CYCLON 12 Volt 1x6 Shrink Wrap

Product Number	Description	Length mm	Width mm	Height mm	Weight kg	Leads
0810-0108	2.5Ah D Dbl. Slot	205.2	37.6	67.6	1.13	No
0810-0109	2.5Ah D	205.2	37.6	67.6	1.14	Yes
0860-0108	4.5Ah DT Dbl. Slot	205.2	37.6	102.4	1.76	No
0860-0109	4.5Ah DT	205.2	37.6	102.4	1.77	Yes
0800-0108	5.0Ah X Dbl. Slot	266.2	47.5	79.2	2.27	No
0800-0109	5.0Ah X	266.2	47.5	79.2	2.28	Yes
0850-0108	8.0Ah E Dbl. Slot	266.2	47.5	106.4	3.05	No
0850-0109	8.0Ah E	266.2	47.5	106.4	3.07	Yes



### CYCLON 12 Volt 1x6 ABS Case

Product Number	Description	Length mm	Width mm	Height mm	Weight kg	Leads
0810-0016	2.5Ah D Dbl. Slot	209.6	39.4	69.6	1.24	No
0810-0075	2.5Ah D Sing. Slot	209.6	39.4	69.6	1.25	Yes
0800-0016	5.0Ah X Dbl. Slot	270.8	49.8	80.0	2.36	No
0800-0072	5.0Ah X Sing. Slot	270.8	49.8	80.0	2.38	Yes

All dimensions, excluding weight, are maximum

\*Consult EnerSys Customer Service Department for availability; due to special assembly

## CYCLON BC Single Cell performance specifications

### Constant current discharge - amps to 1.67Vpc @ 25°C

Products	DURATION									
	5 min	10 min	15 min	30 min	60 min	90 min	5 hr	8 hr	10 hr	20 hr
BC cell (25Ah)	118.3	72.8	54.3	32.2	19.3	14.0	4.85	3.14	2.55	1.33

### Constant power discharge - watts per cell to 1.67Vpc @ 25°C

Products	DURATION									
	5 min	10 min	15 min	30 min	60 min	90 min	5 hr	8 hr	10 hr	20 hr
BC cell (25Ah)	197.3	142.4	105.5	63.5	36.8	25.6	9.20	6.04	4.95	2.60

### Charging Voltage/Temperature/Life:

Products	CHARGING VOLTAGE PER CELL		TEMPERATURE RANGE		LIFE EXPECTANCY	
	Cyclic	Float	Storage & discharge	Charge	C/5 Cycle life 100% DOD	Float life at 25°C (20°C)
BC cell (25Ah)	CV 2.45-2.50 CC*	CV 2.27-2.35 CC*	-65°C to +80°C	-40°C to +80°C	300	10 years (15 years)

*Maximum recommended storage time before recharge - 24 months @ 25°C or 2.0Vpc, whichever is earlier*

*Atmospheric pressure range - Vacuum to 810 kPa*

*Mounting - Terminal torque must not exceed 3.95 Nm.*

*\*Users planning to use CC should consult the EnerSys Application Support Department*



### CYCLON 12 Volt 2x3 25.0Ah Case

Product Number	Description	Length mm	Width mm	Height mm	Weight kg	Leads
0820-0020	BC Double Slot, Copper Straps	204.5	138.4	184.2	10.4	No

*All dimensions, excluding weight, are maximum*

#### UL Recognised Component. Meets UL 1989

Caution: Batteries contain toxic materials (Pb and H<sub>2</sub>SO<sub>4</sub>) • Avoid short circuit • Do not charge in gas-tight container  
Sealed-lead rechargeable battery must be recycled or disposed of properly. Contact EnerSys Customer Service for details.

### CYCLON Single Cell mechanical specifications (E, G, H & J - Maximum)

Products	DIMENSIONS										Weight gm
	A mm	B mm	C mm	D	E mm	F mm	G mm	H mm	I mm	J mm	
D cell	6.9	13.0	4.75	22°	6.9	0.64	61.2	1.3	3.3	34.3	178.0
DT cell	6.9	13.0	4.75	22°	6.9	0.64	96.0	1.3	3.3	34.3	274.4
X cell	7.4	15.5	6.35	22°	8.6	0.64	72.9	1.5	3.6	44.5	362.0
E cell	7.4	15.5	6.35	22°	8.6	0.64	100.1	1.5	3.6	44.5	489.9
J cell	8.1	18.8	7.92	22°	12.4	0.81	123.2	1.3	3.8	51.8	839.2

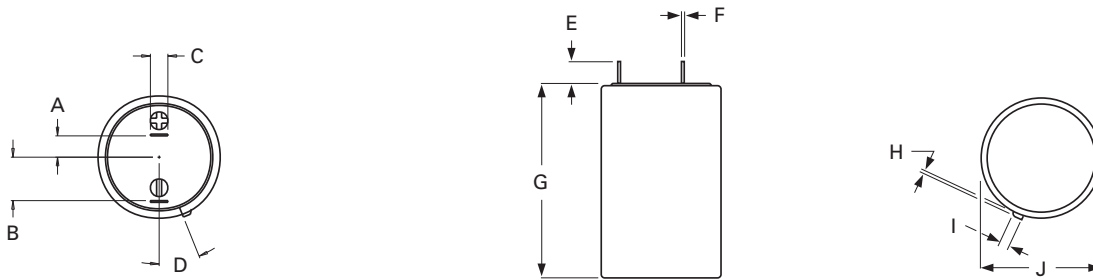

### CYCLON BC Single Cell mechanical specifications (F, G & I - Maximum)

Products	DIMENSIONS										Weight kg
	A mm	B mm	C	D mm	E mm	F mm	G mm	H mm	I mm		
BC cell	16.5	33.0	22°	14.5	5.6	158.8	1.5	3.3	65.3	1.67	

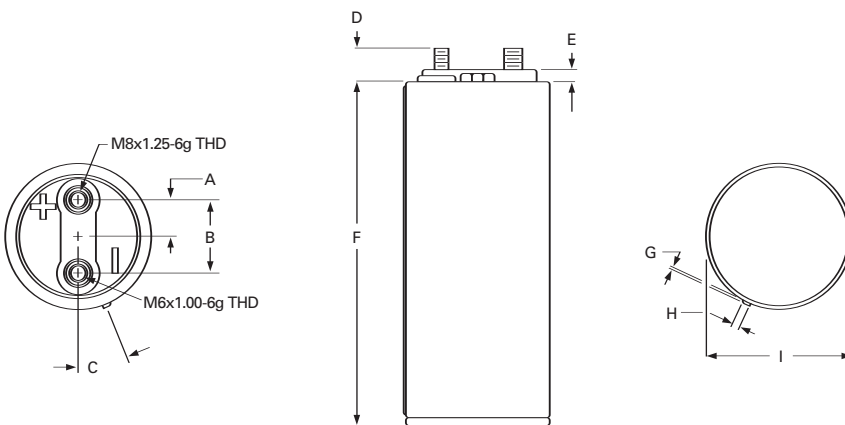

### CYCLON Single Cell constant current (CC) discharge

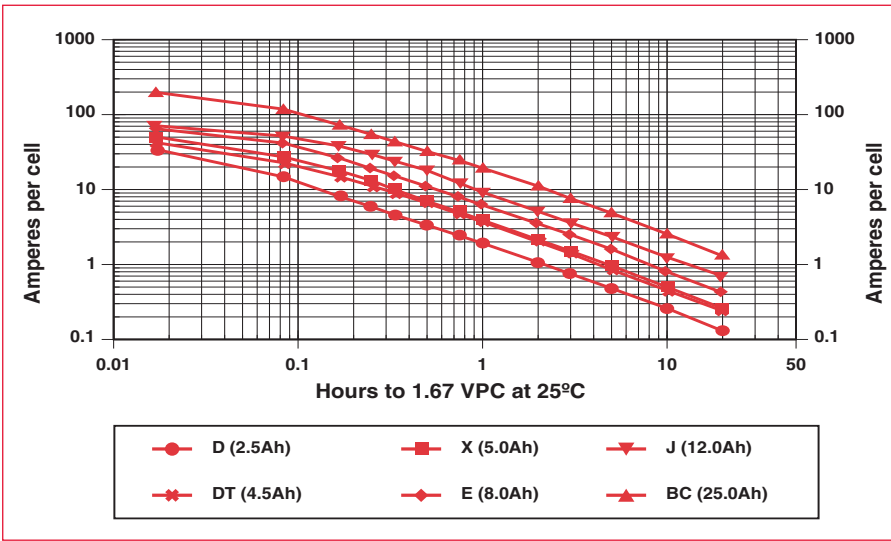

### CYCLON Single Cell constant power (CP) discharge

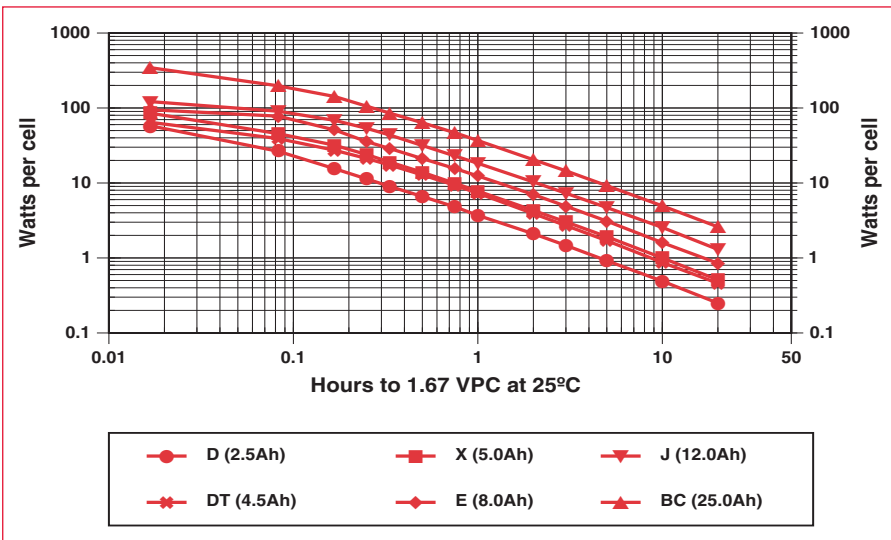

## CYCLON 4V/6V Monobloc performance specifications

### 4V & 6V Constant current discharge - amps to 1.67Vpc @ 25°C

Products	DURATION									
	5 min	10 min	15 min	30 min	60 min	90 min	5 hr	8 hr	10 hr	20 hr
D cell (2.5Ah)	14.3	8.1	5.9	3.4	1.9	1.4	.48	.32	.26	.13
X cell (5.0Ah)	28.9	18.1	13.5	7.1	4.0	2.8	1.0	.61	.52	.26
E cell (8.0Ah)	41.7	26.4	19.0	11.0	6.2	4.4	1.6	1.0	.81	.42

### 4V & 6V Constant power discharge - watts per cell to 1.67Vpc @ 25°C

Products	DURATION									
	5 min	10 min	15 min	30 min	60 min	90 min	5 hr	8 hr	10 hr	20 hr
D cell (2.5Ah)	25.3	15.9	11.7	6.8	3.8	2.7	.93	.60	.49	.25
X cell (5.0Ah)	48.8	32.3	24.2	13.8	7.8	5.6	2.0	1.2	1.0	.52
E cell (8.0Ah)	77.8	51.0	35.5	21.1	12.4	8.9	3.1	2.0	1.7	.85

### Charging Voltage/Temperature/Life

Products	CHARGING VOLTAGE PER BLOC		TEMP RANGE	LIFE EXPECTANCY	
	Cyclic	Float	Storage, discharge & charge	C/5 Cycle life 100% DOD	Float life at 25°C (20°C)
4V D, X, & E Monobloc	CV 4.90-5.00 CC*	CV 4.54-4.70 CC*	-40°C to +40°C	300	Up to 8 yrs (Up to 8 yrs)
6V D, X, & E Monobloc	CV 7.35-7.50 CC*	CV 6.81-7.05 CC*	-40°C to +40°C	300	Up to 8 yrs (Up to 8 yrs)

**Maximum recommended storage time before recharge** - 24 months @ 25°C or 2.0Vpc, whichever is earlier

**Atmospheric pressure range** - Vacuum to 202 kPa

**Mounting** - Each Monobloc is equipped with mounting holes in the cover. The tightening torque for mounting the Monobloc is 2.82 Nm. When using 4 mounting bolts, small spacers (washers) 1 to 3 mm thick should be placed between the battery and the mounting surface to prevent bowing or stressing the battery case

\*Users planning to use CC should consult the EnerSys Application Support Department

**UL Recognised Component. Meets UL 1989**

Caution: Batteries contain toxic materials (Pb and H<sub>2</sub>SO<sub>4</sub>) • Avoid short circuit • Do not charge in gas-tight container  
Sealed-lead rechargeable battery must be recycled or disposed of properly. Contact EnerSys Customer Service for details.



## CYCLON 4V/6V Monobloc standard assemblies

### CYCLON 4 Volt Monoblocs

Product Number	Description	Length mm	Width mm	Height mm	Weight kg
0819-0010	4V, 2.5Ah Monobloc	79.5	46.0	69.9	.36
0809-0010	4V, 5.0Ah Monobloc	96.5	53.8	76.7	.74
0859-0010	4V, 8.0Ah Monobloc	96.8	54.1	101.6	.96



### CYCLON 6 Volt Monoblocs

Product Number	Description	Length mm	Width mm	Height mm	Weight kg
0819-0012	6V, 2.5Ah Monobloc	113.8	46.0	69.9	.52
0809-0012	6V, 5.0Ah Monobloc	139.2	53.8	76.7	.98
0859-0012	6V, 8.0Ah Monobloc	139.2	54.1	101.6	1.43



### CYCLON 12 Volt 2x3 Monoblocs

Product Number	Description	Length mm	Width mm	Height mm	Weight kg
0819-0020	12V, 2.5Ah, 2x3	113.8	89.4	70.4	1.04
0809-0020	12V, 5.0Ah, 2x3	139.2	106.2	77.2	1.96
0859-0020	12V, 8.0Ah, 2x3	139.2	106.2	102.1	2.86



### CYCLON 12 Volt 1x6 Monoblocs

Product Number	Description	Length mm	Width mm	Height mm	Weight kg
0819-0016	12V, 2.5Ah, 1x6	224.5	46.0	70.4	1.04
0809-0016	12V, 5.0Ah, 1x6	276.4	53.8	77.2	1.96
0859-0016	12V, 8.0Ah, 1x6	276.4	54.1	102.1	2.86

All dimensions, excluding weight, are maximum

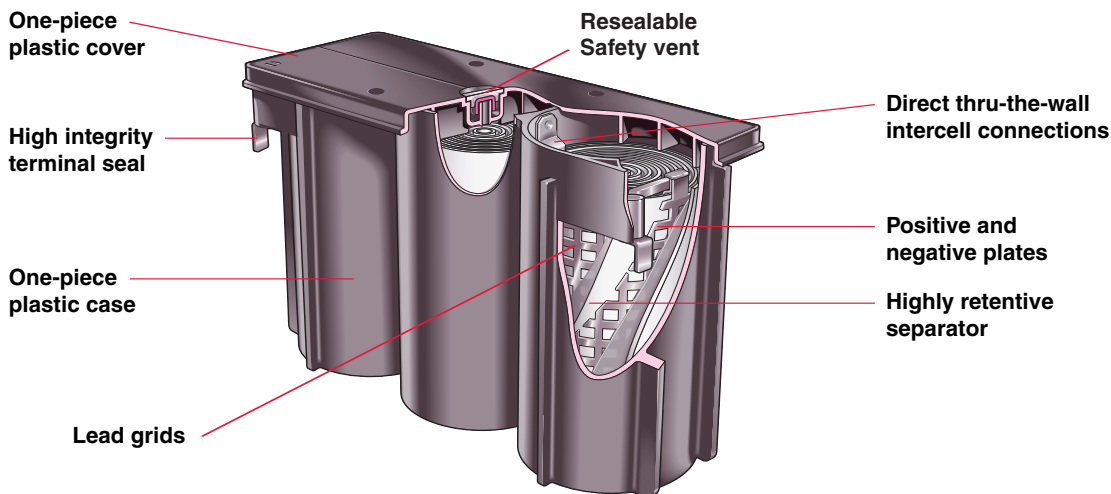



### CYCLON 4V Monobloc mechanical specifications (A, B & C - maximum)

Products	DIMENSIONS						Weight kg	Tabs mm
	A mm	B mm	C mm	D mm	E mm			
D Monobloc	69.9	79.5	46.0	15.5	31.2	.36	4.75x0.64	
X Monobloc	76.7	96.5	53.8	18.5	36.8	.74	6.35x0.64	
E Monobloc	101.6	96.8	54.1	18.5	36.8	.96	6.35x0.64	

### CYCLON 6V Monobloc mechanical specifications (A, B & C - maximum)

Products	DIMENSIONS							Weight kg	Tabs mm
	A mm	B mm	C mm	D mm	E mm	F mm	G mm		
D Monobloc	69.9	113.8	46.0	15.5	31.2	33.8	17.0	.52	4.75x0.64
X Monobloc	76.7	139.2	53.8	18.5	36.8	43.4	21.8	.98	6.35x0.64
E Monobloc	101.6	139.2	54.1	18.5	36.8	43.4	21.8	1.43	6.35x0.64

#### D Monobloc

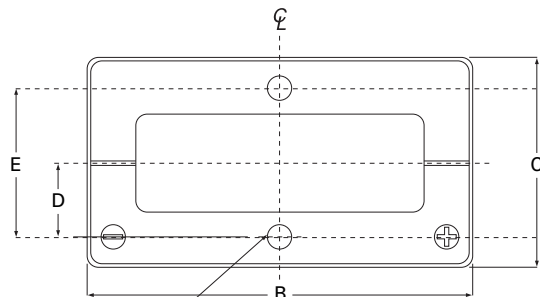
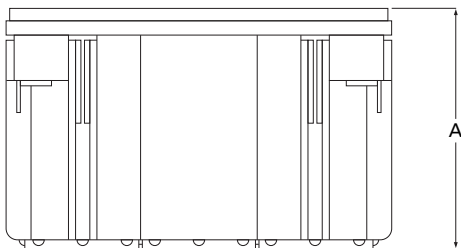

#### X & E Monobloc

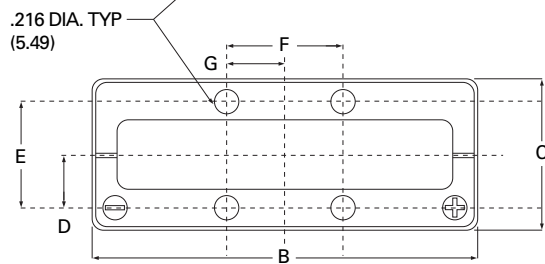
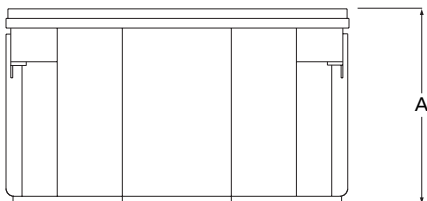

**4V/6V Monobloc constant current (CC) curves to 1.67Vpc**

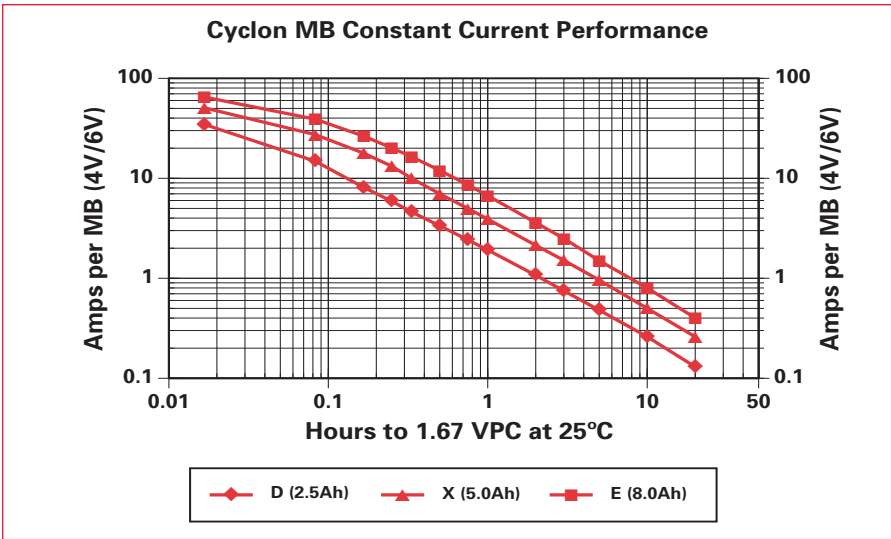

**4V/6V Monobloc constant power (CP) curves to 1.67Vpc**

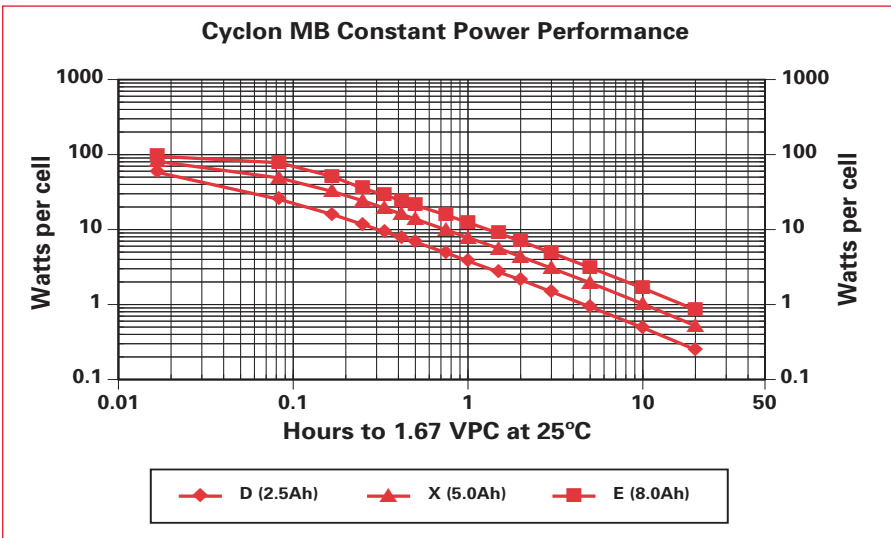

## ENERSYS STANDARD PRODUCT LIST

### SINGLE CELL (sc)

PART NUMBER	DESCRIPTION	VOLTAGE	10 Hr RATE	PERFORMANCE SPECIFICATIONS	MECHANICAL SPECIFICATIONS
0810-0004	D Single Cell (Dsc)	2V	2.5Ah	Page 10	Page 13
0860-0004	DT Single Cell (DTsc)	2V	4.5Ah	Page 10	Page 13
0800-0004	X Single Cell (Xsc)	2V	5.0Ah	Page 10	Page 13
0850-0004	E Single Cell (Esc)	2V	8.0Ah	Page 10	Page 13
0840-0004	J Single Cell (Jsc)	2V	12.0Ah	Page 10	Page 13
0820-0004	BC Single Cell (BCsc)	2V	25.0Ah	Page 12	Page 13

### SINGLE CELL STANDARD BATTERY DESIGNS

PART NUMBER	DESCRIPTION	VOLTAGE	10 Hr RATE	PERFORMANCE SPECIFICATIONS	MECHANICAL SPECIFICATIONS
0810-0102	1x3 Dsc, double slot, shrink wrap	6V	2.5Ah	Page 10	Page 11
0810-0103	1x3 Dsc, shrink wrap, leads	6V	2.5Ah	Page 10	Page 11
0810-0011	1x3 Dsc, double slot, ABS case	6V	2.5Ah	Page 10	Page 11
0810-0077	1x3 Dsc, single slot, ABS case, leads	6V	2.5Ah	Page 10	Page 11
0860-0102	1x3 DTsc, double slot, shrink wrap	6V	4.5Ah	Page 10	Page 11
0860-0103	1x3 DTsc, shrink wrap, leads	6V	4.5Ah	Page 10	Page 11
0800-0102	1x3 Xsc, double slot, shrink wrap	6V	5.0Ah	Page 10	Page 11
0800-0103	1x3 Xsc, shrink wrap, leads	6V	5.0Ah	Page 10	Page 11
0800-0011	1x3 Xsc, double slot, ABS case	6V	5.0Ah	Page 10	Page 11
0800-0071	1x3 Xsc, single slot, ABS case, leads	6V	5.0Ah	Page 10	Page 11
0850-0102	1x3 Esc, double slot, shrink wrap	6V	8.0Ah	Page 10	Page 11
0850-0103	1x3 Esc, shrink wrap, leads	6V	8.0Ah	Page 10	Page 11
0810-0108	1x6 Dsc, double slot, shrink wrap	12V	2.5Ah	Page 10	Page 11
0810-0109	1x6 Dsc, shrink wrap, leads	12V	2.5Ah	Page 10	Page 11
0810-0016	1x6 Dsc, double slot, ABS case	12V	2.5Ah	Page 10	Page 11
0810-0075	1x6 Dsc, single slot, ABS case, leads	12V	2.5Ah	Page 10	Page 11
0810-0114	2x3 Dsc, double slot, shrink wrap	12V	2.5Ah	Page 10	Page 11
0810-0115	2x3 Dsc, shrink wrap, leads	12V	2.5Ah	Page 10	Page 11
0810-0008	2x3 Dsc, double slot, ABS case	12V	2.5Ah	Page 10	Page 11
0810-0067*	2x3 Dsc, Styrene case, leads	12V	2.5Ah	Page 10	Page 11
0860-0108	1x6 DTsc, double slot, shrink wrap	12V	4.5Ah	Page 10	Page 11
0860-0109	1x6 DTsc, shrink wrap, leads	12V	4.5Ah	Page 10	Page 11
0860-0114	2x3 DTsc, double slot, shrink wrap	12V	4.5Ah	Page 10	Page 11
0860-0115	2x3 DTsc, shrink wrap, leads	12V	4.5Ah	Page 10	Page 11
0800-0108	1x6 Xsc, double slot, shrink wrap	12V	5.0Ah	Page 10	Page 11
0800-0109	1x6 Xsc, shrink wrap, leads	12V	5.0Ah	Page 10	Page 11
0800-0016	1x6 Xsc, double slot, ABS case	12V	5.0Ah	Page 10	Page 11
0800-0072	1x6 Xsc, single slot, ABS case, leads	12V	5.0Ah	Page 10	Page 11
0800-0114	2x3 Xsc, double slot, shrink wrap	12V	5.0Ah	Page 10	Page 11
0800-0115	2x3 Xsc, shrink wrap, leads	12V	5.0Ah	Page 10	Page 11

**SINGLE CELL STANDARD BATTERY DESIGNS (continued)**

PART NUMBER	DESCRIPTION	VOLTAGE	10 Hr RATE	PERFORMANCE SPECIFICATIONS	MECHANICAL SPECIFICATIONS
0800-0008	2x3 Xsc, double slot, ABS case	12V	5.0Ah	Page 10	Page 11
0800-0047*	2x3 Xsc, Styrene case, leads	12V	5.0Ah	Page 10	Page 11
0850-0108	1x6 Esc, double slot, shrink wrap	12V	8.0Ah	Page 10	Page 11
0850-0109	1x6 Esc, shrink wrap, leads	12V	8.0Ah	Page 10	Page 11
0850-0114	2x3 Esc, double slot, shrink wrap	12V	8.0Ah	Page 10	Page 11
0850-0115	2x3 Esc, shrink wrap, leads	12V	8.0Ah	Page 10	Page 11
0820-0020	2x3 BCsc, double slot, copper strap	12V	25.0Ah	Page 12	Page 12

**MONOBLOC (mb)**

PART NUMBER	DESCRIPTION	VOLTAGE	10 Hr RATE	PERFORMANCE SPECIFICATIONS	MECHANICAL SPECIFICATIONS
0819-0010	D Monobloc (Dmb)	4V	2.5Ah	Page 15	Page 17
0809-0010	X Monobloc (Xmb)	4V	5.0Ah	Page 15	Page 17
0859-0010	E Monobloc (Emb)	4V	8.0Ah	Page 15	Page 17
0819-0012	D Monobloc (Dmb)	6V	2.5Ah	Page 15	Page 17
0809-0012	X Monobloc (Xmb)	6V	5.0Ah	Page 15	Page 17
0859-0012	E Monobloc (Emb)	6V	8.0Ah	Page 15	Page 17

**MONOBLOC STANDARD BATTERY DESIGNS**

PART NUMBER	DESCRIPTION	VOLTAGE	10 Hr RATE	PERFORMANCE SPECIFICATIONS	MECHANICAL SPECIFICATIONS
0819-0016	1x6 Dmb	12V	2.5Ah	Page 15	Page 16
0819-0020	2x3 Dmb	12V	2.5Ah	Page 15	Page 16
0809-0016	1x6 Xmb	12V	5.0Ah	Page 15	Page 16
0809-0020	2x3 Xmb	12V	5.0Ah	Page 15	Page 16
0859-0016	1x6 Emb	12V	8.0Ah	Page 15	Page 16
0859-0020	2x3 Emb	12V	8.0Ah	Page 15	Page 16

CAPACITY RATINGS BASED ON END OF DISCHARGE VOLTAGE OF 1.67 VOLTS/CELL AT 25°C

\*Consult EnerSys Customer Service Department for availability; due to special assembly



www.enersys.com

**EnerSys**  
 P.O. Box 14145  
 Reading, PA 19612-4145  
 USA  
 Tel: +1-610-208-1991  
 +1-800-538-3627  
 Fax: +1-610-372-8613

**EnerSys EMEA**  
 Houtweg 26  
 1140 Brussels  
 Belgium  
 Tel: +32 (0)2 247 94 47  
 Fax: +32 (0)2 247 94 49

**EnerSys Asia**  
 49, Yanshan Road  
 Shekou, Shenzhen  
 Guangdong 518066  
 China  
 Tel: +86-755-2689 3639  
 Fax: +86-755-2689 8013

Contact:
----------

© 2006 EnerSys. All rights reserved.  
 Trademarks and logos are the property of EnerSys and its affiliates unless otherwise noted.